





Shirts

2011

 P: AeroCool 0711, sublimation feasibility

 Front zipper

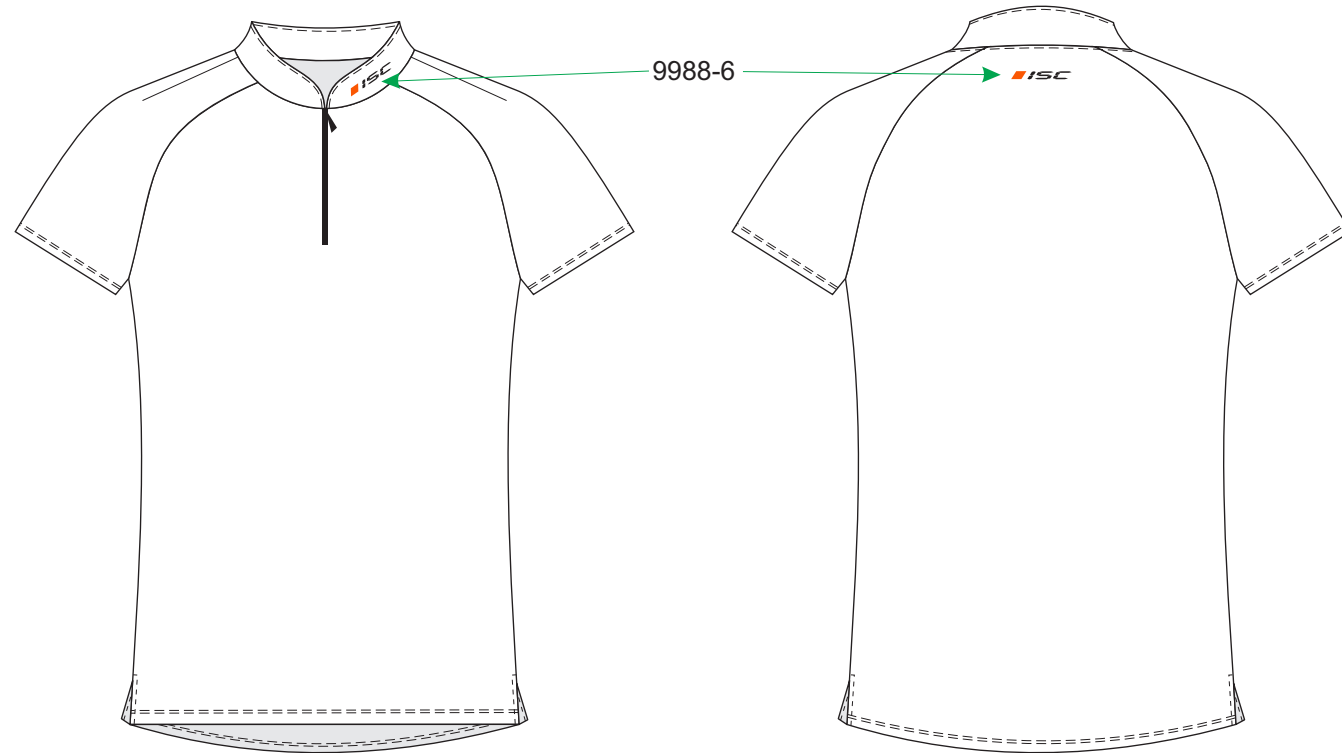

Description:

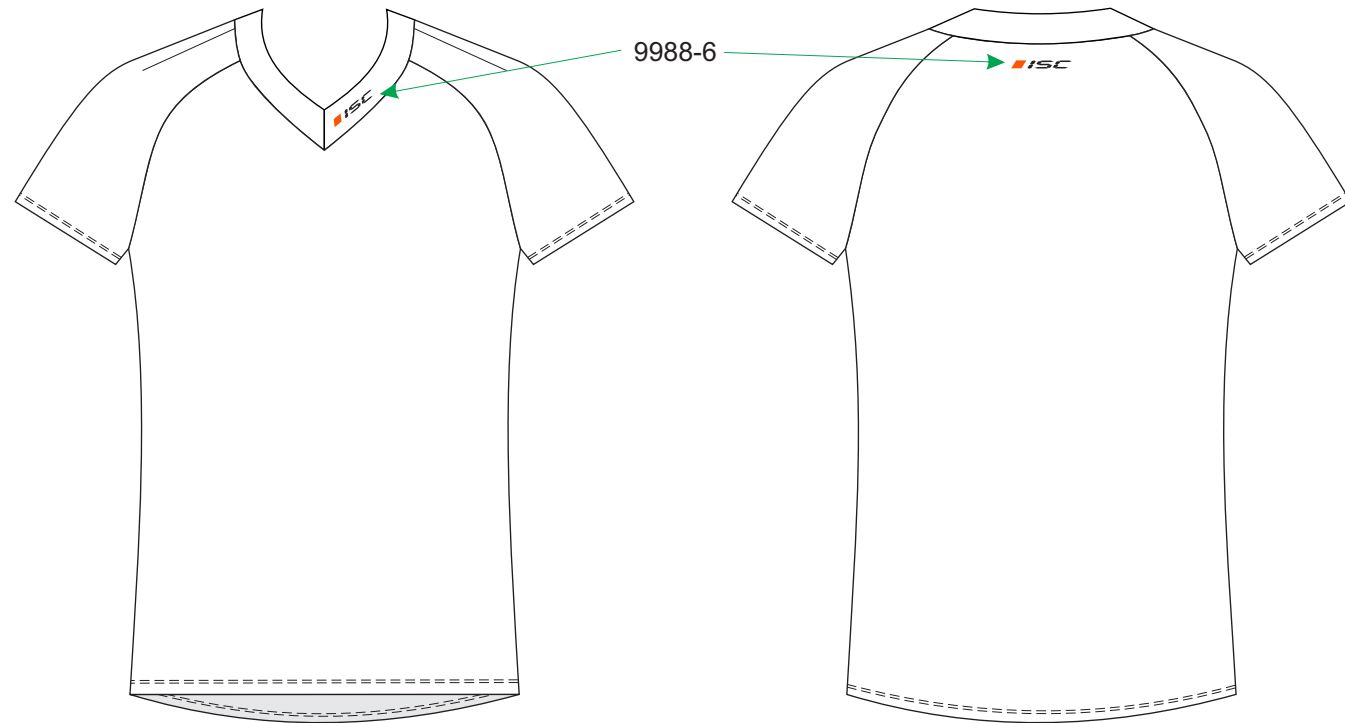

- * Body fit;
- * Breathable and slightly elastic fabric, with sublimation feasibility;
- * Short sleeves;
- * Short front zipper;
- * Low collar.

 P: AeroCool 0711, sublimation feasibility



Description:

- * Body fit;
- * Breathable and slightly elastic fabric, with sublimation feasibility;
- * V-neck.

-  P: AeroCool 0711, sublimation feasibility
-  L: Lycra Olympic S01810, sublimation feasibility

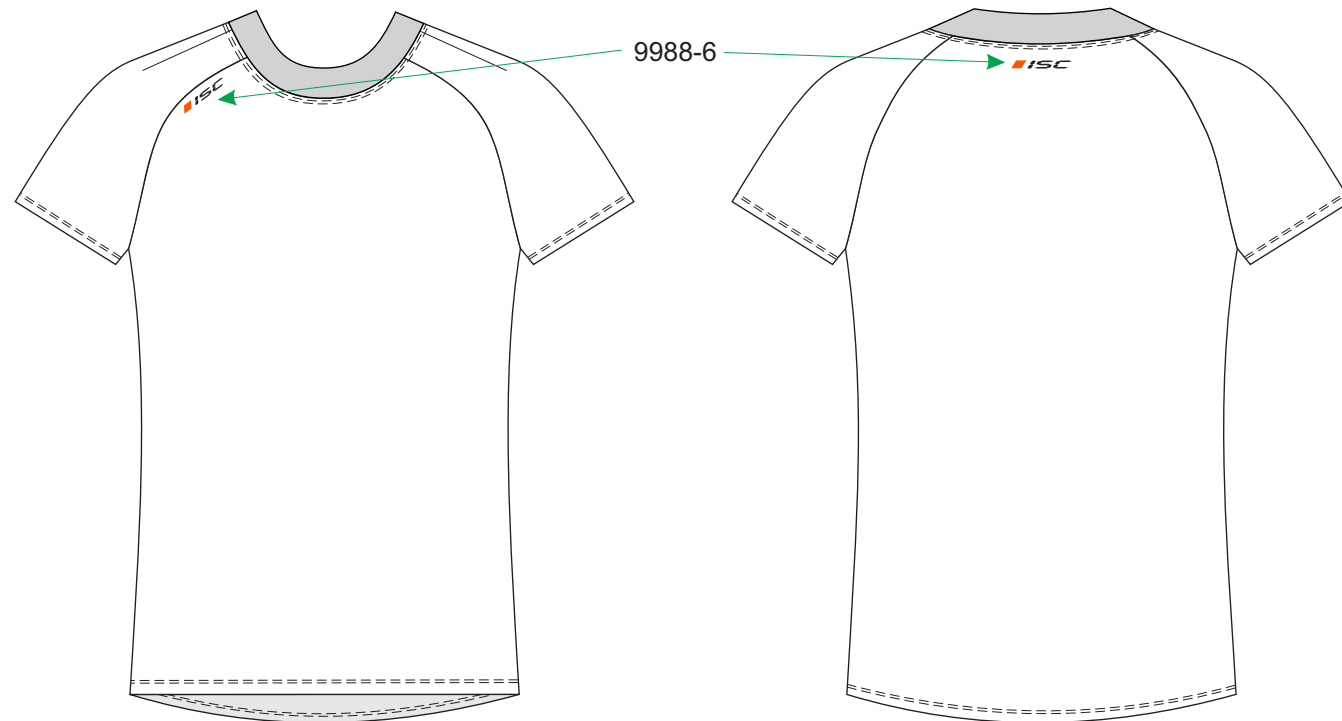

Description:

- * Body fit;
- * Breathable and slightly elastic fabric, with sublimation feasibility;
- * U-neck.

 P: AeroCool 0711, sublimation feasibility

 Flatlockseams

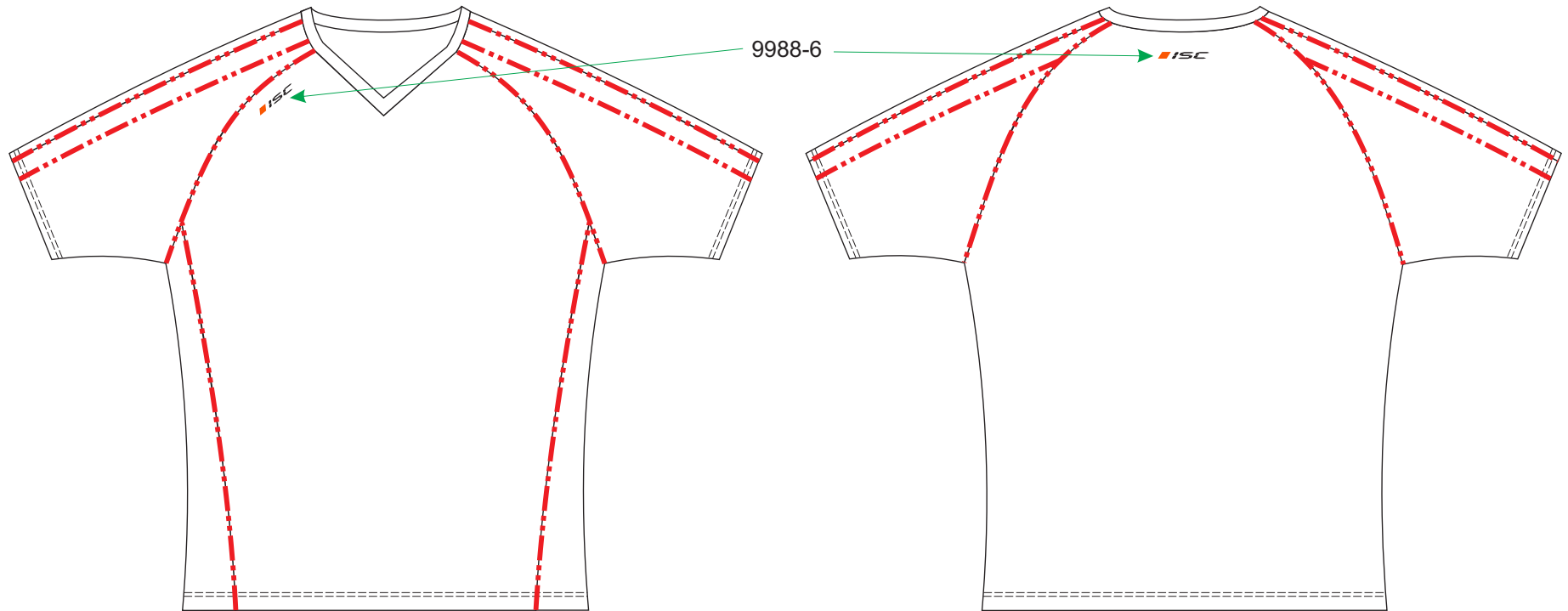

Description:

* Breathable and slightly elastic fabric, with sublimation feasibility;

* V-neck.

 P: AeroCool 0711, sublimation feasibility

 Front zipper

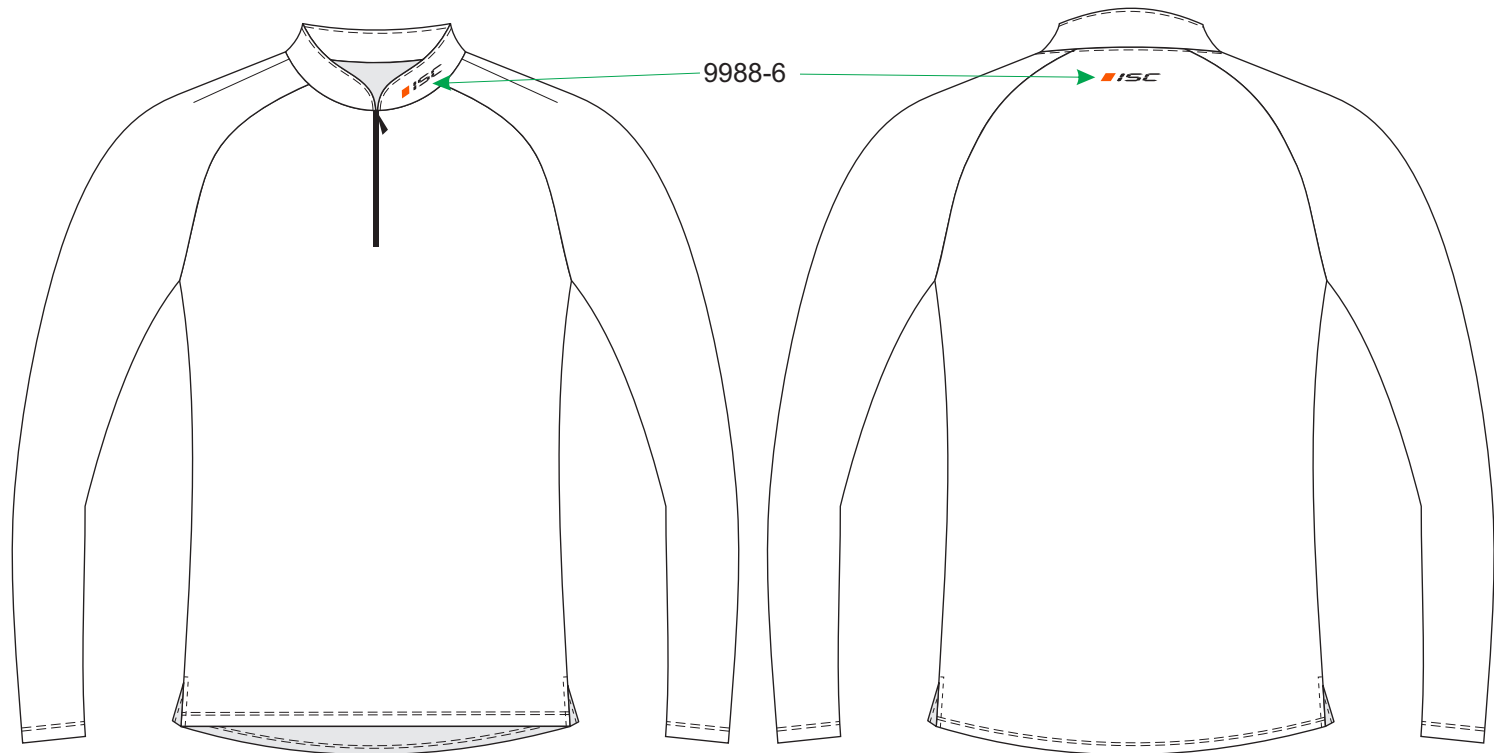

Description:

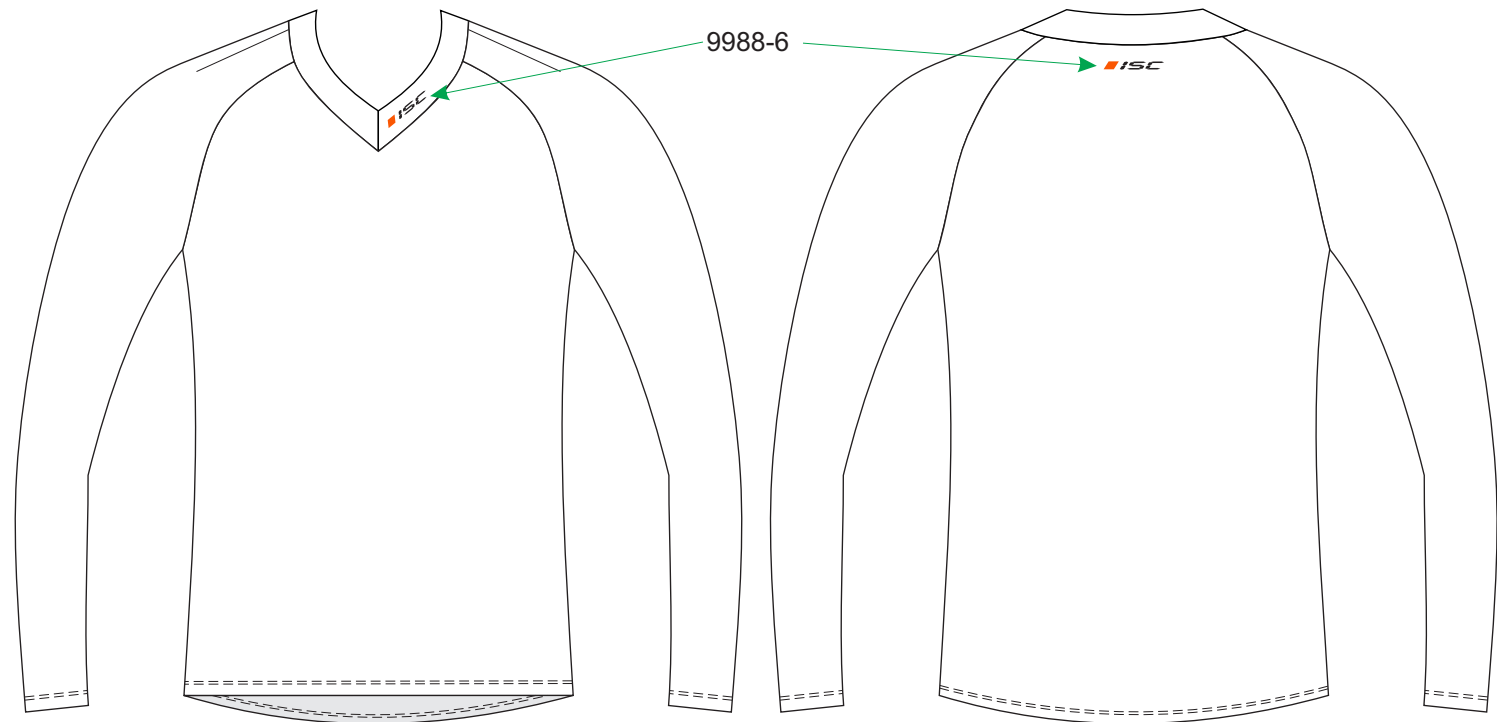

- * Body fit;
- * Breathable and slightly elastic fabric, with sublimation feasibility;
- * Short front zipper;
- * Low collar.

 P: AeroCool 0711, sublimation feasibility



Description:

- * Body fit;
- * Breathable and slightly elastic fabric, with sublimation feasibility;
- * V-neck.

-  P: AeroCool 0711, sublimation feasibility
-  L: Lycra Olympic S01810, sublimation feasibility

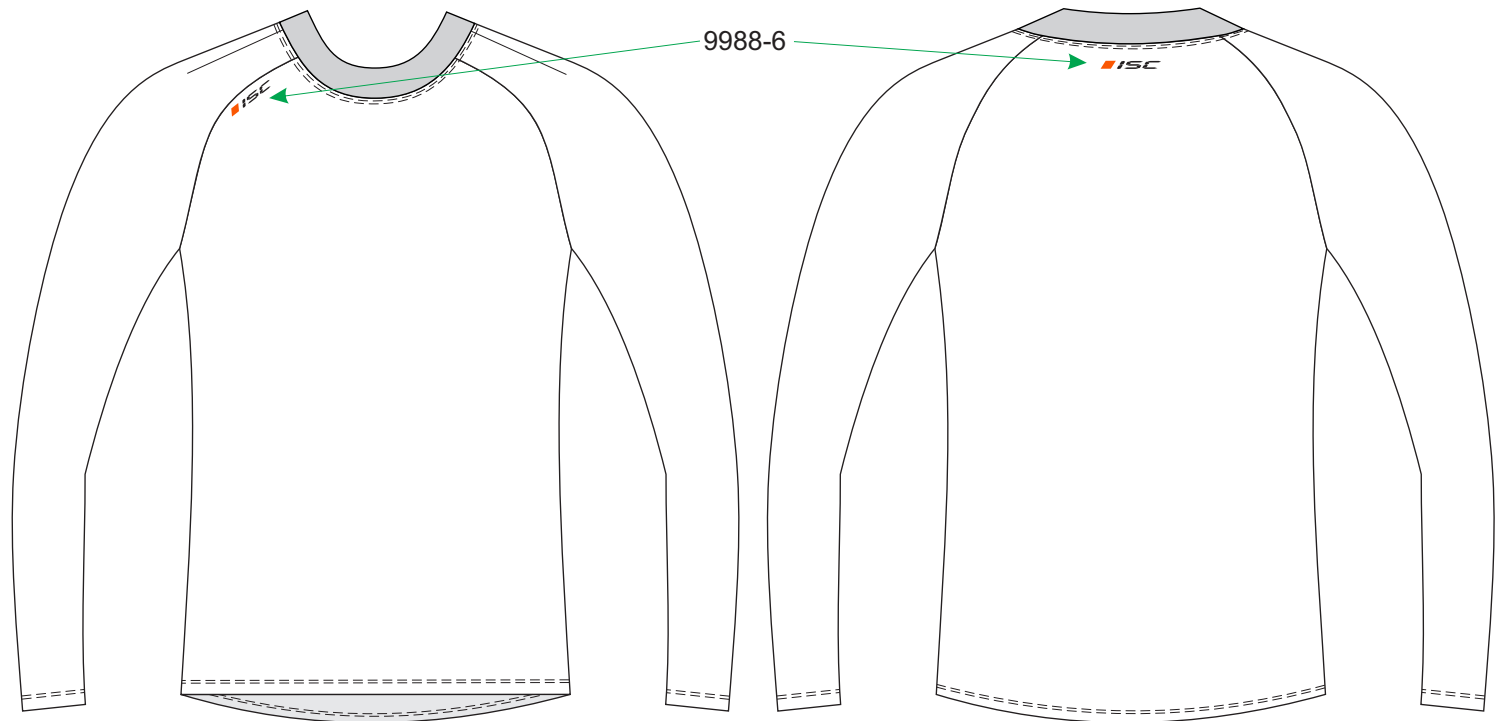

Description:

- * Body fit;
- * Breathable and slightly elastic fabric, with sublimation feasibility;
- * U-neck.

 P: AeroCool 0711, sublimation feasibility

 Flatlockseams

 Front zipper

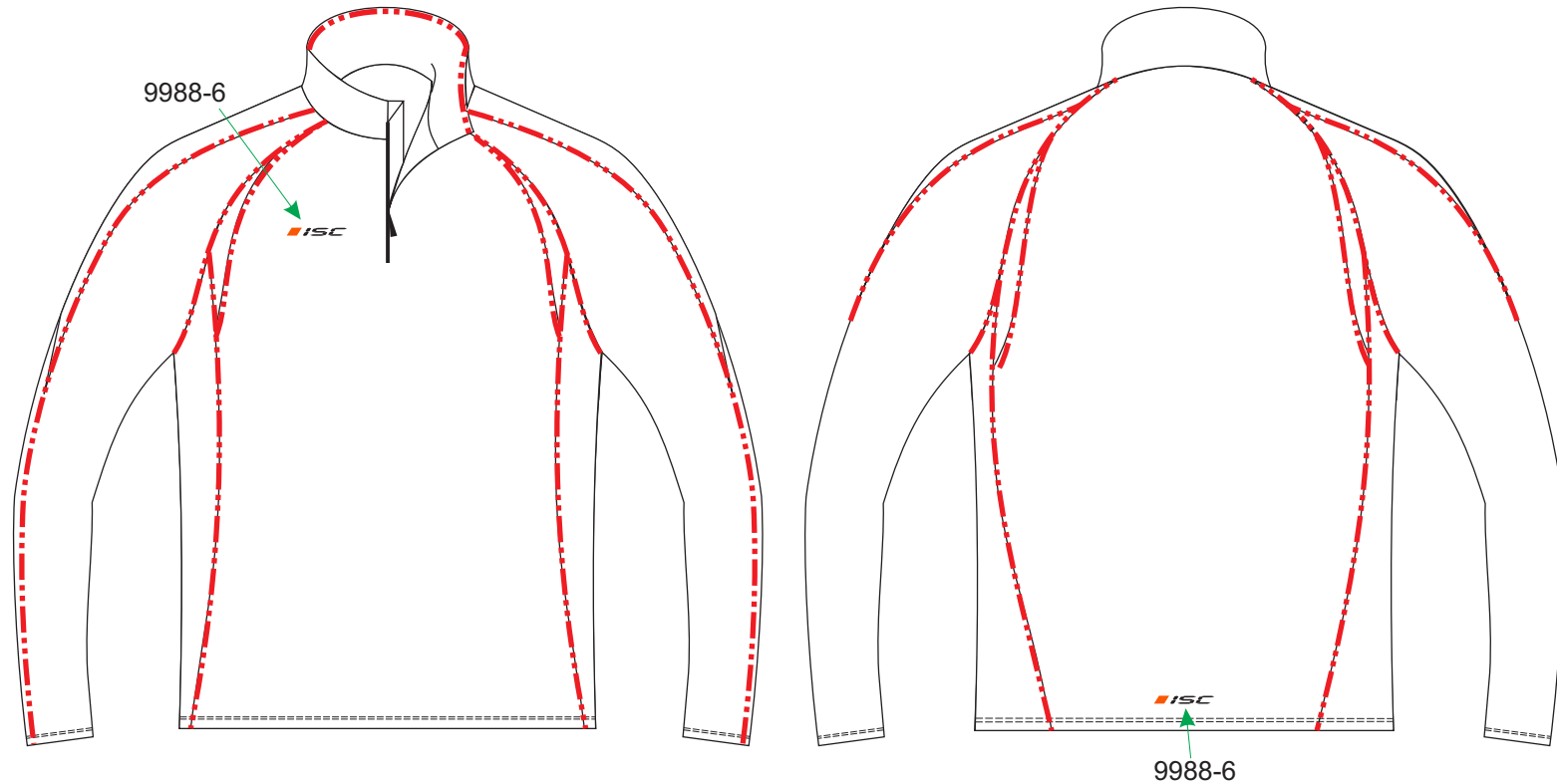

Description:

- * Breathable and slightly elastic fabric, with sublimation feasibility;
- * Short front zipper;
- * Collar;
- * Zipper garage to protect chin.

 P: AeroCool 0711, sublimation feasibility

 Flatlockseams

 Front zipper

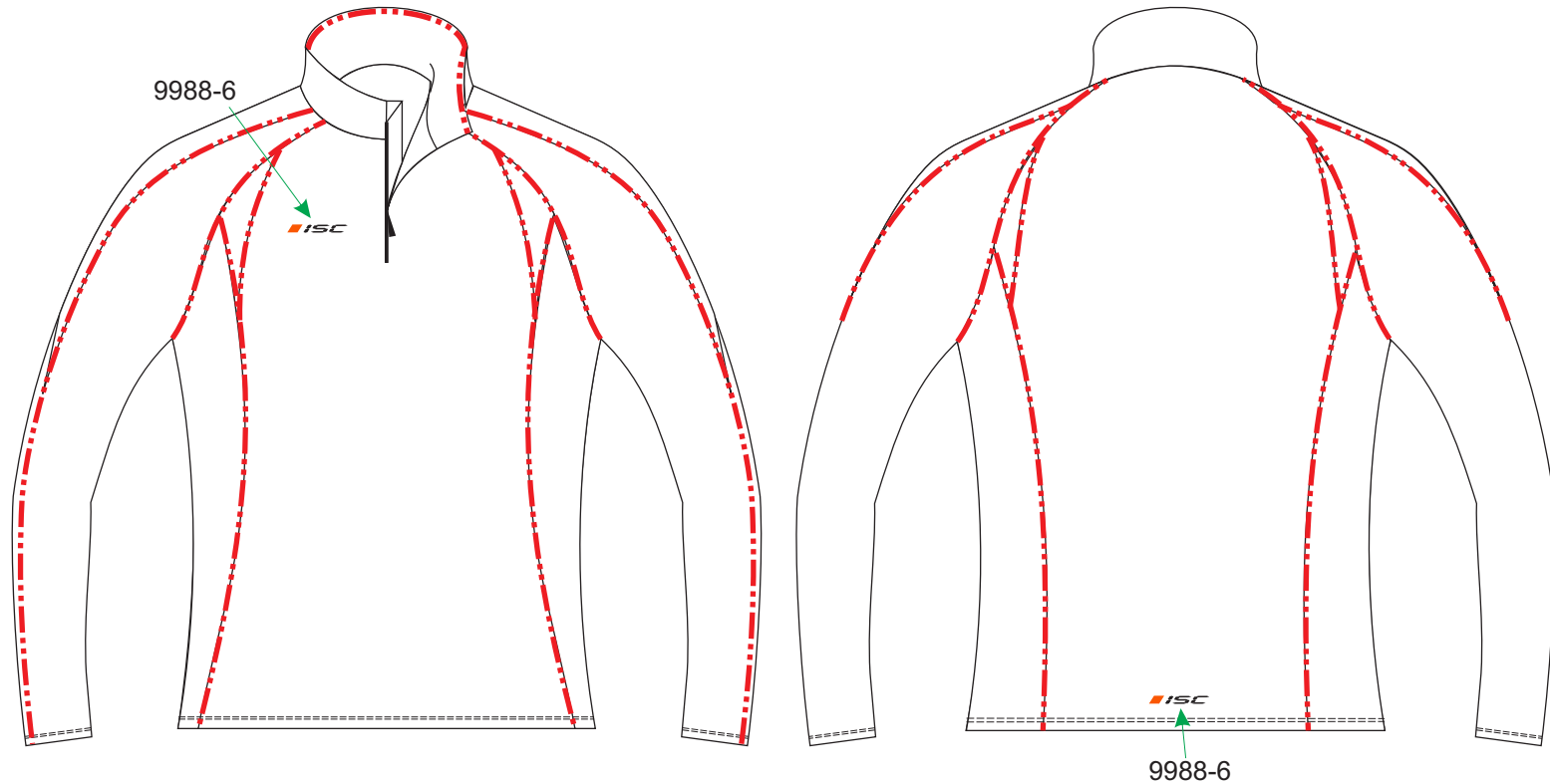

Description:

- * Breathable and slightly elastic fabric, with sublimation feasibility;
- * Short front zipper;
- * Collar;
- * Zipper garage to protect chin.

 P: AeroCool 0711, sublimation feasibility

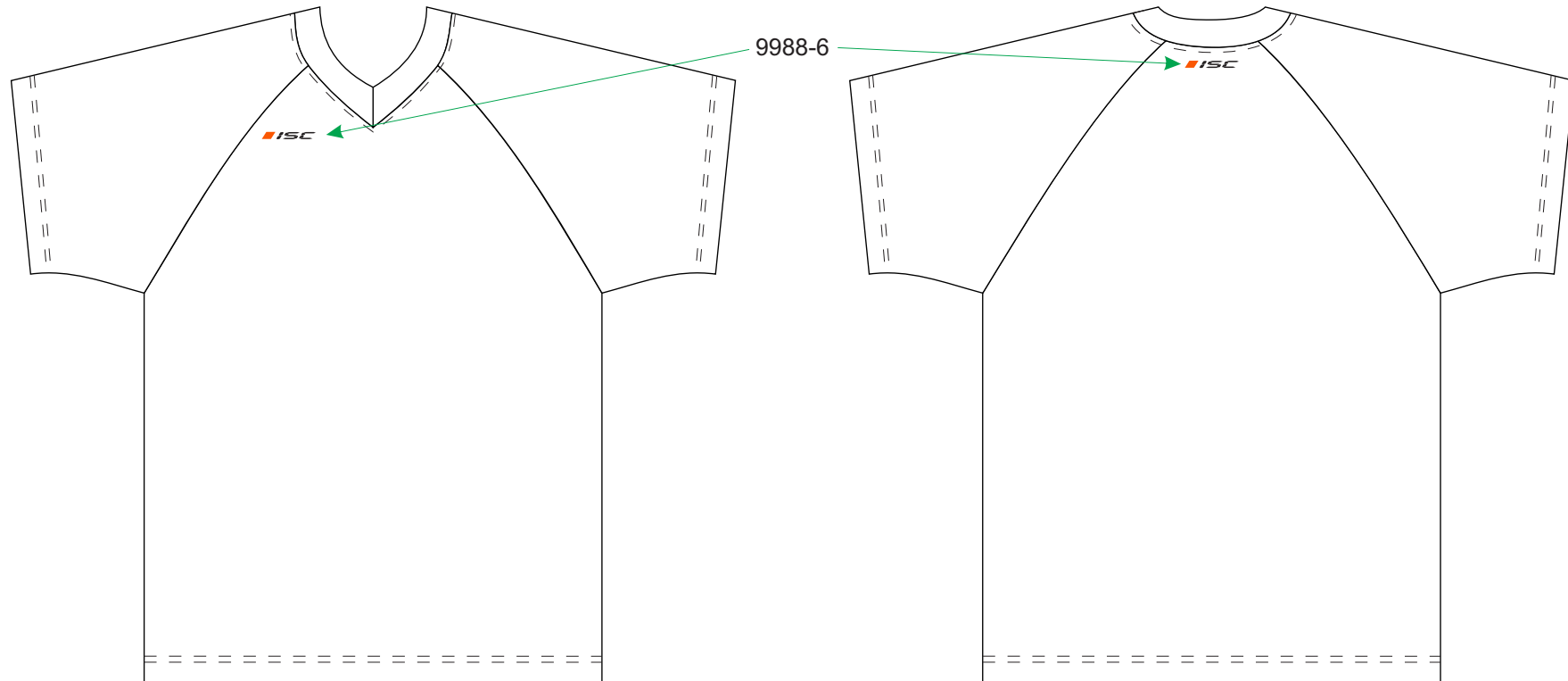

Description:

- * Loose fit;
- * Breathable and slightly elastic fabric, with sublimation feasibility;
- * V-neck.

 P: AeroCool 0711, sublimation feasibility

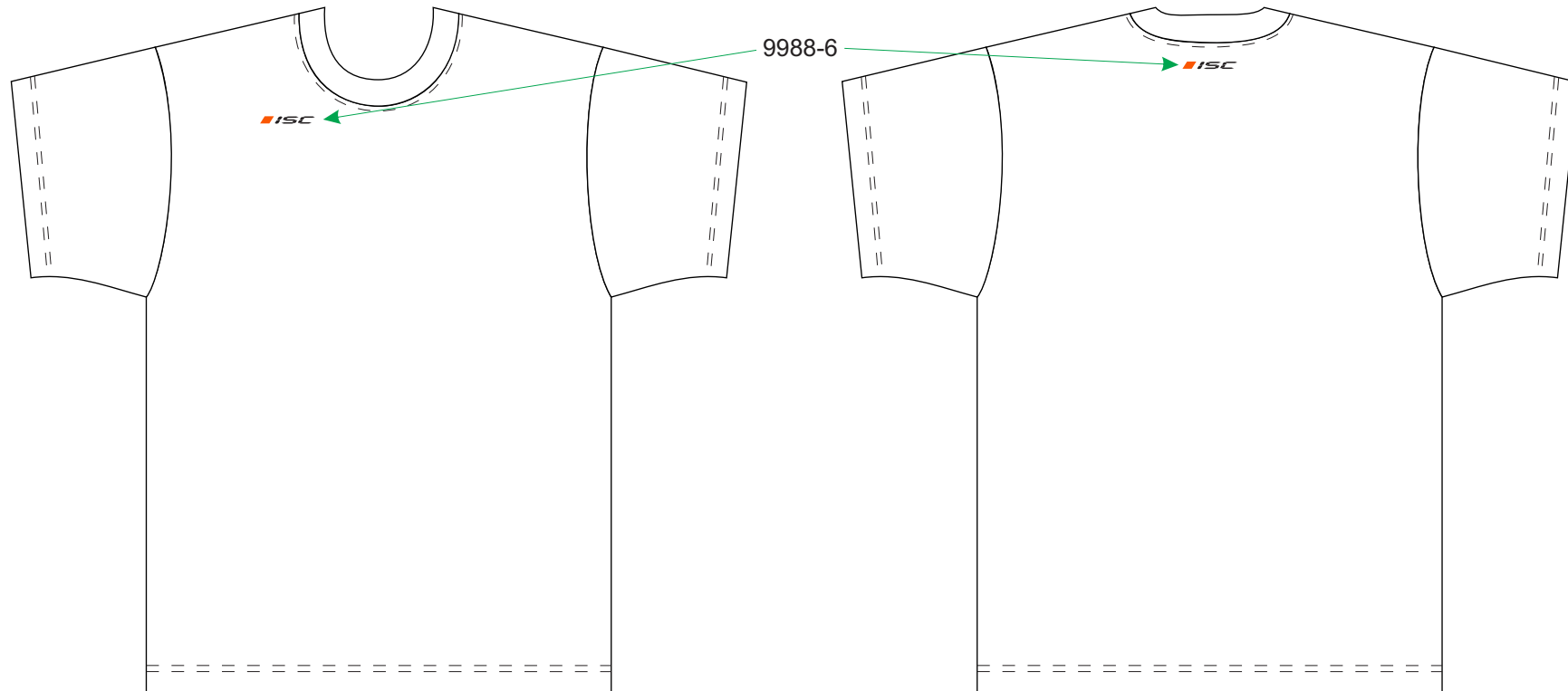

Description:

- * Loose fit;
- * Breathable and slightly elastic fabric, with sublimation feasibility;
- * U-neck.

 P: AeroCool 0711, sublimation feasibility

 Front zipper

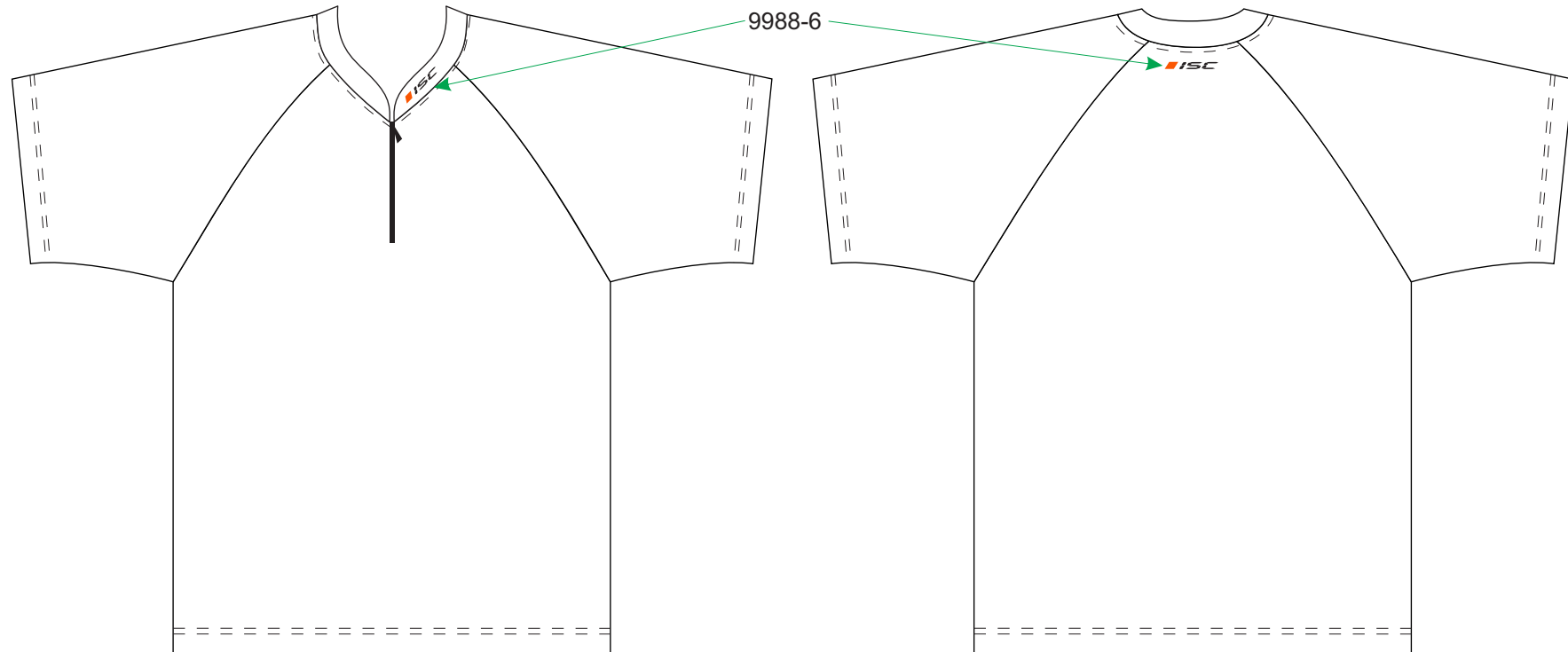

Description:

- * Loose fit;
- * Breathable and slightly elastic fabric, with sublimation feasibility;
- * Sleeves are 5cm longer than Fan;
- * Short front zipper;
- * Low collar.